

Variation in three Bornean species of Lonchodinae: *Carausius cristatus* Brunner, *Lonchodes modestus* (Brunner), and *Lonchodes strumosus* (Brunner).

P.E. Bragg, 51 Longfield Lane, Ilkeston, Derbyshire, DE7 4DX, U.K.

Key words

Phasmida, Rearing, Variation, Borneo, *Carausius cristatus*, *Lonchodes modestus*, *L. strumosus*.

Introduction

In terms of variation within a species, the Lonchodinae appear to be a rather inconsistent subfamily, some members exhibit almost no variation while others show some remarkable variation in colour, size, and shape. Variation in size and colour are to be expected as both are subject to the effect of environment as well as genetic control, size for example may be influenced by diet, or by temperature. Variation in body shape is however a different matter, and it is in this respect that the Lonchodinae is an inconsistent group. One member of the subfamily, *Phenacephorus cornucervi* Brunner, is perhaps the most variable phasmid in the world, I have yet to see two identical females although the males are always more or less identical.

Bornean members of the genus *Carausius* Stål show little variation although in the related *Lonchodes* Gray variation is not unusual; *Carausius cristatus* Brunner seems to be an exception. The genus *Lonchodes* contains species showing little variation (e.g. *Lonchodes brevipes* Gray), and species showing considerable variation, including the two under consideration here: *L. modestus* (Brunner), and *L. strumosus* (Brunner). In the case of *Lonchodes modestus* the species appears to have been described three times because of the variations which occur. In the cases of *L. strumosus* and *C. cristatus* no variation has been recorded previously. All three species have been reared successfully and it is as a direct result of attempts to rear them that these variations have been observed.

For each species I have given a description, including the variations; examples of the variations are also illustrated. A complete set of measurements for each species is given in table 1; these are taken from the largest and smallest specimens in my collection and include both wild caught and reared specimens.

Carausius cristatus Brunner, 1907

Carausius cristatus Brunner, 1907: 270; Hausleithner, 1990: 396, fig 2b (egg); Hausleithner, 1991: 224, figs 5, 6a-c (♂).

Culture history

The culture PSG 120 is derived from four females and three males which I collected in 1990 at an altitude of 1580m, near Mt Kinabalu Park Head Quarters in Sabah. This was supplemented by eggs from two females which I collected from the same locality in 1992.

Distribution

Brunner's original description of the species states that it is from Kinabalu, Borneo. I have found it to be a common species around Kinabalu Park HQ, frequently seeing it at night along many of the paths through the forest. The Sarawak Museum has a single specimen from Mt Kinabalu; I believe there are also some specimens in Leiden Museum but I do not have any notes on where they were collected. Hausleithner (1990: 396) refers to a specimen, identified by Brunner, which is labelled "Brunei"; such a vague locality is of little use as what is now Sabah was part of Brunei until 1877, depending on when it was collected, it is even possible that the specimen was from Kinabalu. The only other published record is Hausleithner's (1991: 224) record of specimens collected by C.L. Chan at Kinabalu Park H.Q. There is therefore only one confirmed locality for

this species.

Variation

Females and the offspring from the original 1990 collection were very consistent, with no lobes on the head or body, even the colour was quite uniform. This was also true of the females which I collected on my second trip in 1992, I was therefore rather surprised when some of the offspring from this second collection had lobes on the head, thorax, and abdomen. Rearing these enabled me to identify a female which had remained unidentified from my first trip! As one would expect, the males show no such variation.

Females (Figures 3-5 & 8-9)

Body and legs mid to dark brown, lighter coloured specimens often with two dark triangular patches on 5th abdominal segment, ventral surface of body may be paler than dorsal; posterior face of hind femora reddish near the base. Head, body and legs granulose, body finely tuberculate, tubercles often darker than base colour. Dorsal surface of body with a fine longitudinal carina. Femora and tibiae with setose carinae. Body of more or less uniform width throughout (about 4mm).

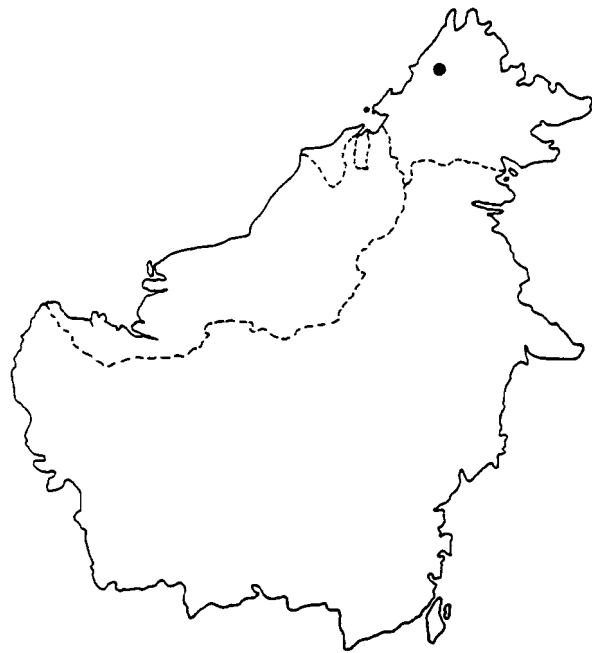

Figure 1 Distribution of *Carausius cristatus*.

Antennae almost as long as fore legs, basal segment flattened, second segment swollen, remainder slender. Head one-and-a-half times longer than wide, with a transverse ridge between the eyes (figure 9); rarely with two lobes forming a large crest between the eyes (figures 5 & 8).

Pronotum longer than wide, anterior margin slightly raised. Mesonotum widening very slightly, rarely with a transverse crest on the posterior margin (figure 5). Metanotum three times longer than the median segment. Mesosternum and metasternum granulose and finely tuberculate. Abdominal segments 2-6 of similar length, 7th slightly shorter, 8th short, 9th very short with hind margin raised, 10th very short with apex indented, lamina supraanalis short with a rounded apex. Rarely the posterior margin of 5th segment has a transverse crest (figure 5). Abdominal sternites 2-6 granulose, 7th and operculum granulose and tuberculate. Praeopercular organ composed of a depression and two triangular lobes. Operculum deep, with a slight keel and a rounded apex. Cerci short and cylindrical.

Fore and middle femora longer than the tibiae, hind femur shorter than the tibia. Base of fore femur strongly compressed and incurving; ventro-posterior carina with two small spines near the apex. Middle and hind femora strongly laterally compressed; anterior and posterior ventral carinae with 2-3 spines near the apices, one spine on ventro-posterior of middle femur is a triangular serration, others are all minute spines. Fore tibia with a lamina of uniform width running along the dorsal surface. First tarsomere of fore tarsus lobed.

Typical specimens lack the crests on the head, mesonotum and 5th abdominal segment. Of my four

crested specimens, one has only the head and abdominal crests, the others have all three crests.

Males (Figures 2, 6-7 & 10)
 Body and legs dark green, with a small pair of black spines on the metanotum, hind femur with basal two-thirds of posterior surface red. Whole body slender and of uniform width (about 1.5mm). Head, body and middle femora granulose, mesonotum and metanotum finely tuberculate; carinae of tibiae setose.

Antennae long and slender, longer than the fore legs; basal segment flattened. Head almost twice as long as wide, with two large spines between the eyes (Figure 10).

Pronotum one-and-a-half times longer than wide, anterior margin indented. Mesonotum of uniform width, granulose and finely tuberculate. Metanotum and median segment distinguishable only with magnification (and then with difficulty); both are slightly wider than the mesonotum. The posterior of the metanotum has a pair of small black spines (figure 7). Abdominal segments 2-7 of similar length and four times longer than wide, 8th shorter and widening, 9th wider than long, 10th laterally flattened and divided longitudinally. Poculum short, reaching to end of 9th tergite, angular, with a rounded rim (figure 6). Cerci short and conical.

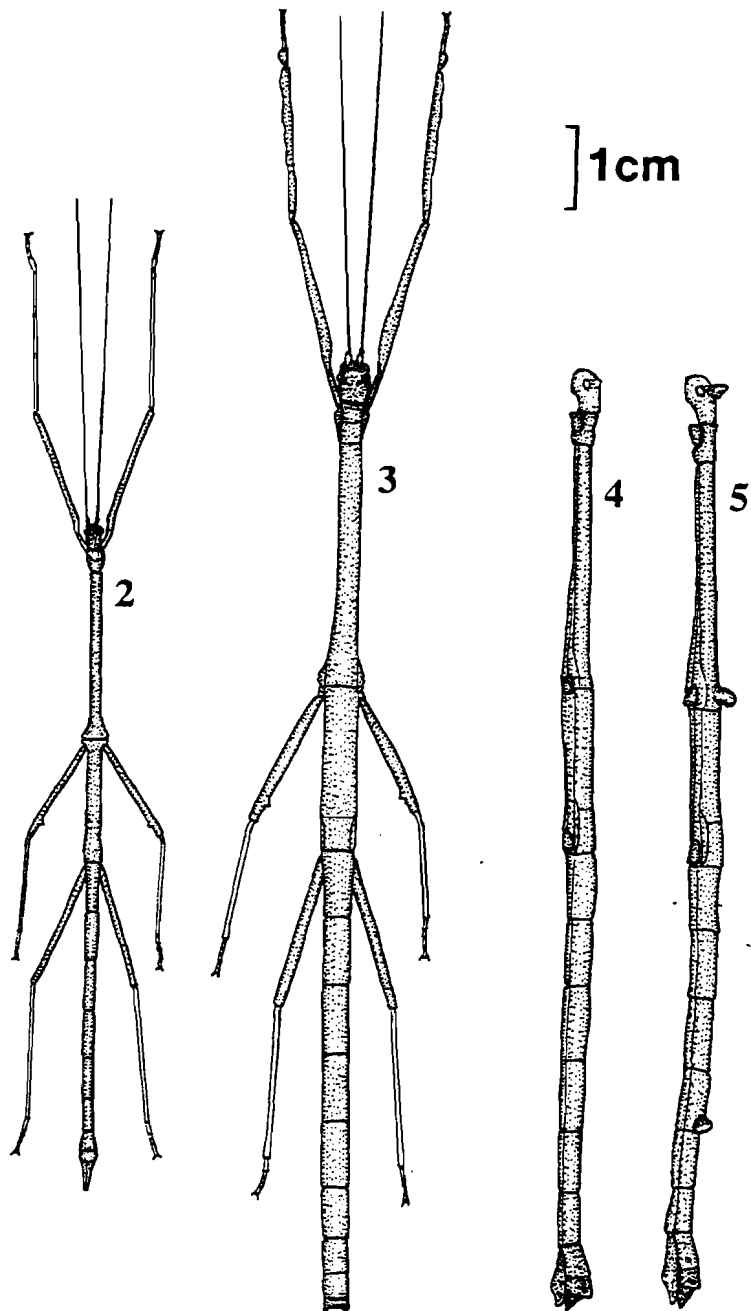

Figures 2-5 *Carausius cristatus*, 2 male, 3 & 4 typical female, 5 variation in the female.

Figures 6-10 *Carausius cristatus*

- 6 Male: apex of abdomen
- 7 Metanotum of male, showing spines.
- 8 Head of female with crest.
- 9 Head of typical female.
- 10 Head of male.

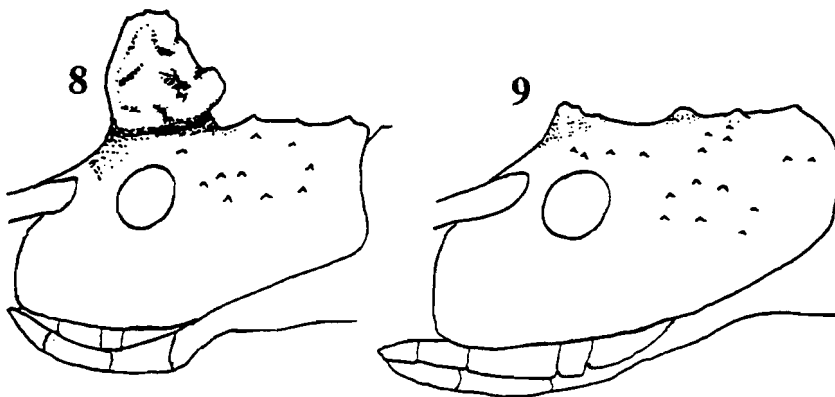
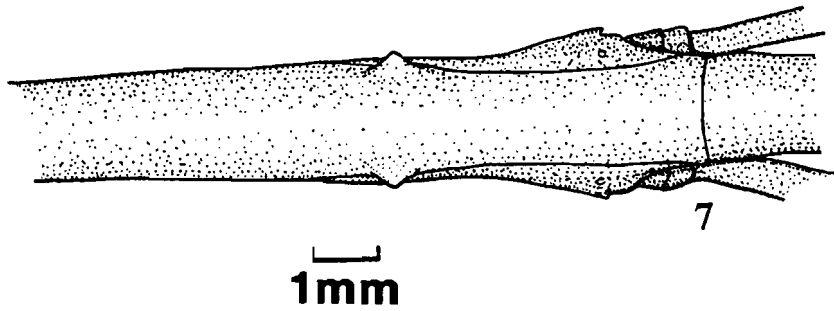
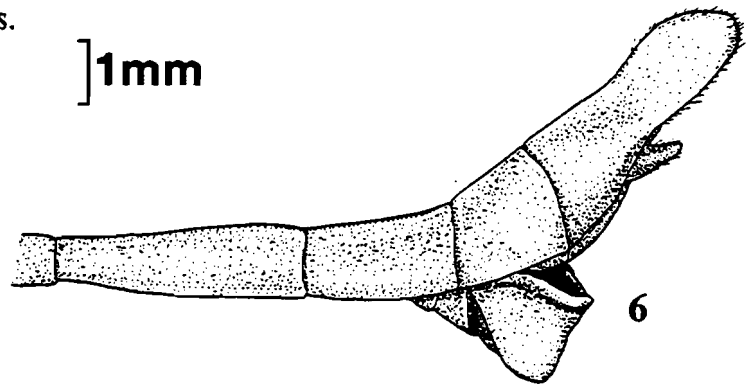

Fore femora sharply curved and compressed at the base, with a pair of small spines near the apex of the ventro-posterior carinae. Middle femora with a small spine on each ventral carina near the apex, often with an additional minute or small spine. Hind femora laterally compressed, ventral carinae each with two minute spines near the apex. Tibiae all unarmed.

Eggs (Figures 11-13)

Capsule ovoid, longer than high, with a small collar; micropylar plate on a very slightly swollen mound. Capsule and micropylar plate uniformly mid brown, surface densely punctate. In dehydrated eggs the capitulum is darker brown than the capsule. Micropylar plate oval, narrower at the opercular end, with the micropylar cup at the polar end. Operculum oval, slightly narrowing at dorsal surface, with a central capitulum. Typically: length 2.6-2.7mm, height 1.9-2.0mm, width 1.7-1.8mm, capitulum length (dehydrated) 0.25-0.35mm.

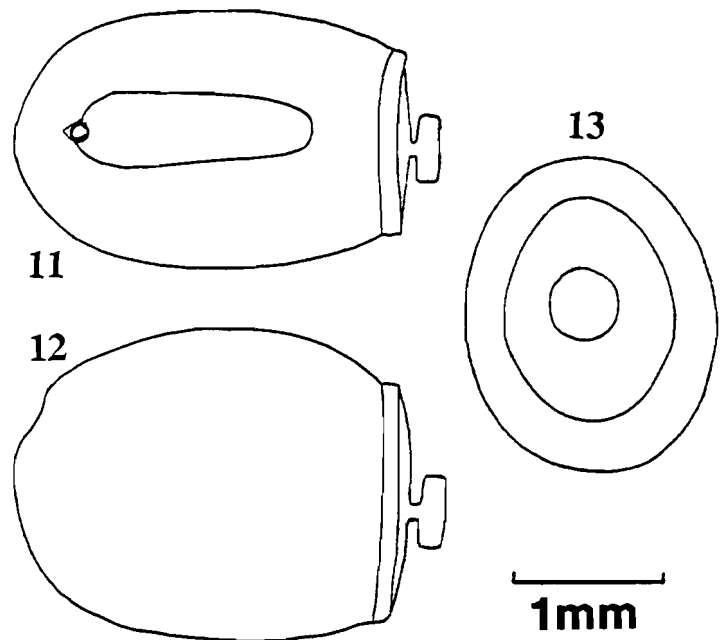

Figures 11-13 *Carausius cristatus* egg: dorsal, lateral, and opercular views.

Rearing

This seems to be an easy species to rear. I kept them in a 60cm x 30cm x 30cm cage my standard construction (Bragg, 1987, 1989), with the sides fully enclosed with polythene to maintain a high humidity. They feed readily on bramble, eucalyptus, raspberry, rose and pyracantha, and would probably accept quite a wide variety of plants although I have not tried any others. Some of my wild caught adults lived for seven months; as I have no idea how long they had already been adult, and I did not record this for ones which I reared, I do not know how long they live. It would be reasonable to expect them to live for more than seven months as adults.

They lay about 10 eggs per week (1.35 per day, measured from November to February) and the hatch rate seemed reasonably high although I did not measure it. Eggs take six months to hatch when kept at room temperature.

Before I stopped keeping this species I gave away quite a lot of eggs so there should be plenty of cultures within the PSG.

Lonchodes modestus (Brunner, 1907)

Prisomera modestum Brunner, 1907: 286.

Prisomera modesta; Giglio-Tos, 1910: 24.

Lonchodes modestus (Brunner); Günther, 1932: 384, fig 11.1 (♂), 11.2 (♀), 13.10 (♀), 13.15 (♂); Günther, 1943: 153; Hausleithner, 1989: 102, fig 3g (egg).

Prisomera modestissimum Brunner, 1907: 286. Synonymised by Günther, 1932c: 384.

Prisomera excretum Brunner, 1907: 289. Synonymised by Günther, 1932c: 384.

Günther considered that *Prisomera modestum*, *P. modestissimum* and *P. excretum* were variations on a single species. Although I have not examined the original specimens described by Brunner, the variation in size and form of this species makes it very likely that Brunner could have considered the variations to be different species. Giglio-Tos was uncertain about the identity of his specimen, although he did not say so, it is possible that he had difficulty deciding between the three species described by Brunner. It is worth remembering that Brunner, Giglio-Tos and Günther did not have the opportunity to rear these insects and see the eggs and variations which are produced.

Culture origins

The culture of PSG 138 is derived from several sources. The original material is from the Indonesian island of Lombok and I believe it was collected by Eric van Gorkom. Although I have only seen eggs of this stock they agree with the eggs of my own stock; Frank Hennemann sent me a sketch of the middle femur of a Lombok specimen, this also agrees with my material. I have collected this species in three areas of Borneo. I collected one pair from Sepilok in Sabah in 1990, and in 1993 I collected several specimens from two areas of Central Kalimantan: a logging camp at Kelambenkari which is on the river Sabangau near Palangkaraya, and a logging camp on the Ratu Miri River. Although the female from Sabah lived for five months and laid 43 eggs, I now know that these eggs were unusually pale which may be related to the fact that none of them hatched. The specimens from Kalimantan died before I returned home but a number of eggs had been laid and a culture was established from these. Eric van Gorkom has also collected *L. modestus* in Kalimantan. Material collected in Kalimantan by Eric, and my material from Kelambenkari is much smaller than my material from Ratu Miri and Sepilok.

Distribution

In addition to Sepilok, Palangkaraya, and Ratu Miri, I have examined specimens in Leiden Museum from Bettotan, which is near Sandakan in Sabah, from Balekpapan in East Kalimantan, from Long Bloe Oe in Central Kalimantan, and from a rather vague central East Borneo ("Midden O-Borneo"). Giglio-Tos (1910: 24) recorded the species from Samarinda, in Kalimantan. Although Giglio-Tos was not certain of the identity of his two specimens, this is understandable given the variation in this species so I am assuming that they were correctly identified. All specific localities are plotted as dots on the distribution map (figure 14), the vague locality is indicated by a large ring in the middle of East Kalimantan.

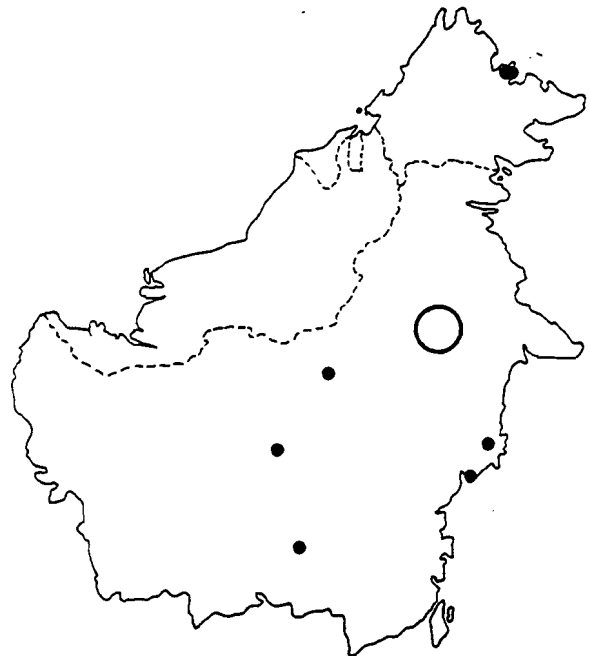
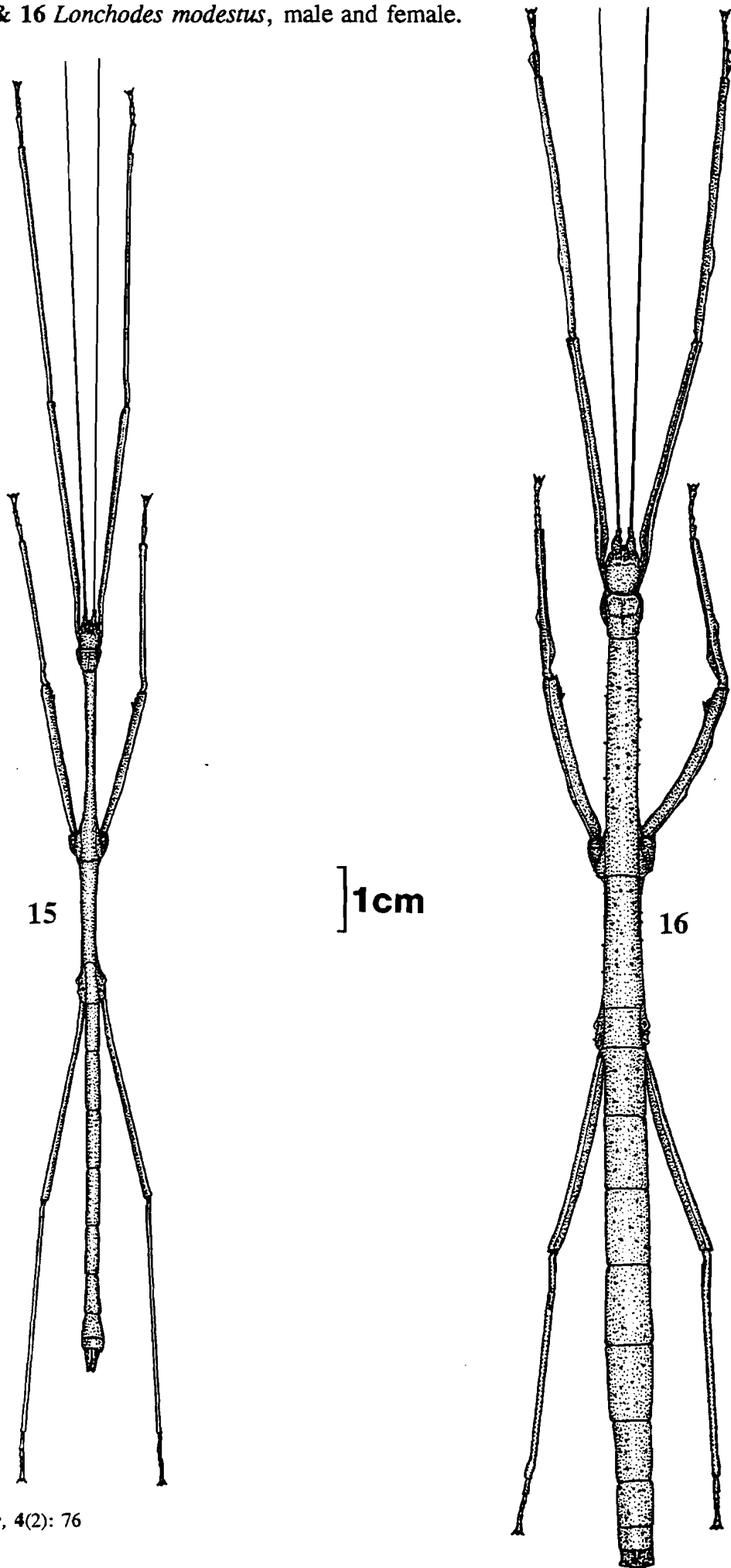

Figure 14 Distribution of *Lonchodes modestus*.

Female (Figures 16-22)

Head, body and legs mid-brown, or mid-green, or combination of these colours; base of fore femur and posterior surface of hind femur red; posterior surface of hind tibia may be red. Legs speckled with dark brown; body occasionally with some dark speckles or small dark patches, and occasionally with some pale grey patches. Head, dorsal surface of body, ventral surface of

Figures 15 & 16 *Lonchodes modestus*, male and female.



thorax, and legs densely granulate and finely tuberculate.

Antennae about as long as the fore legs. Head slightly longer than wide, with a small ridge between the eyes, top of the head slightly rounded. Pronotum about one-and-a-half times longer than wide. Mesonotum widening gradually. Metanotum widening slightly, two-and-a-half or three times longer than median segment. Abdominal segments 2-6 of uniform width and length, 7th slightly shorter and narrowing, 8-10 short and of uniform width, 10th with a small longitudinal carina, lamina supraanalis short with a rounded apex. Occasionally (PEB-1841 only) abdominal segments 1-7 have a small tubercle on the hind margin, on 5th segment this can be quite a large swollen double tubercle. The praeopercular organ is a triangular lobe which narrows abruptly at the mid point. Operculum straight, keeled, with a rounded apex. Cerci short and conical.

Fore femur with base strongly compressed and incurving, apex of ventro-posterior carina with one small and, occasionally, one minute spine.

Ventro-posterior carina of mid femur with one medium and two minute spines at the apex, ventro-anterior with one small and two minute spines at the apex. Hind femora strongly laterally compressed, ventral carinae with two minute spines at the apex. Dorsal surface of middle femur variable, ranging from two almost imperceptible swellings to two triangular lobes (Figures 17-19).

Anterior tibia variable, dorsal surface with or without a small rounded lobe one third of the way from the base. Base of mid tibia with a very small triangular lobe on the ventral surface; dorsal surface variable, ranging from no perceptible lobe to a distinct triangular or almost semicircular lobe (Figures 20-22). Hind tibia without lobes. Fore tarsus with a rounded lobe on basal tarsomere, lobe varies in size. All tarsi with 4th tarsomere extremely short.

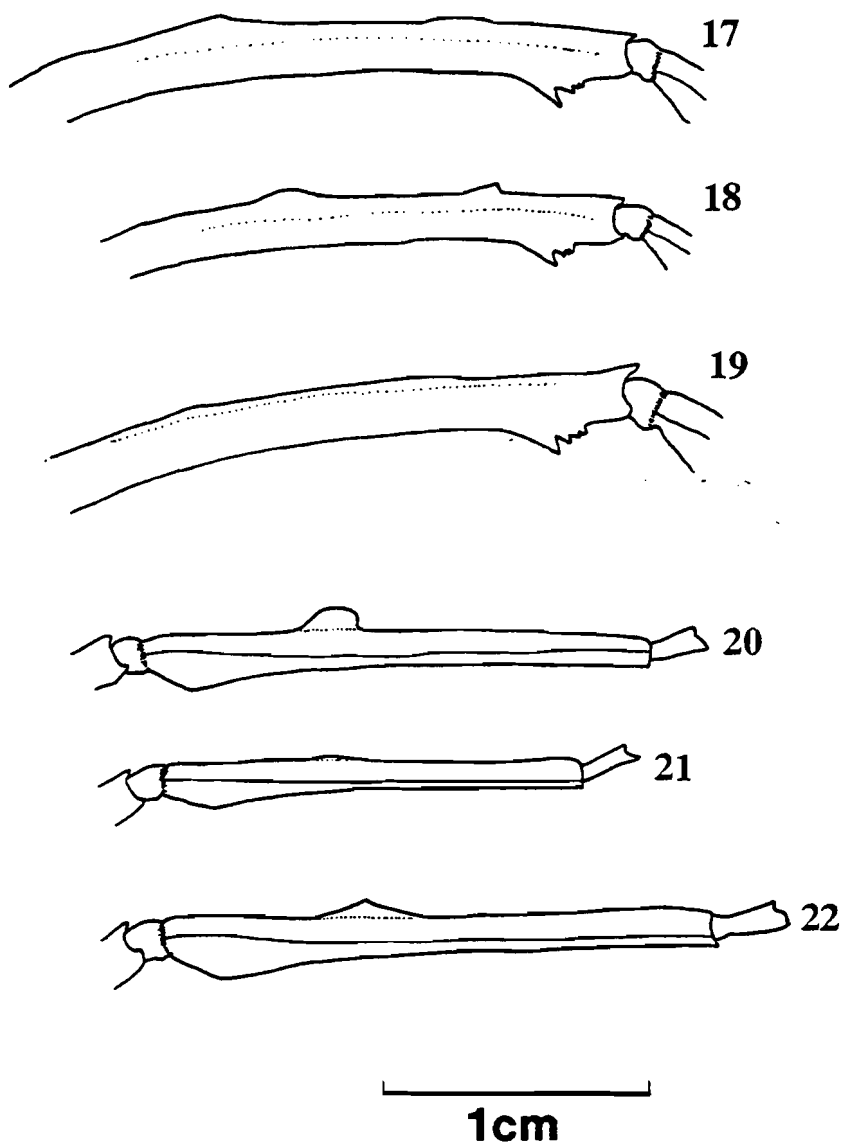

Figures 17-19 *L. modestus*: mid femora of females.

Figures 20-22 *L. modestus*: mid tibiae of females.

The lobes on the femora and tibiae are relatively larger and therefore much more obvious in the female nymphs than in the adults.

Male (Figures 15 & 23)

A typical *Lonchodes* male; slender, with the body and legs unarmed except for the usual spines on the undersides of the apices of the femora. Head, body and legs granulose; mid-brown, or reddish-brown, or greenish-brown, or a combination of these colours; posterior surface of hind femora reddish brown. Body of uniform width throughout, except for slight widening where the legs join the body.

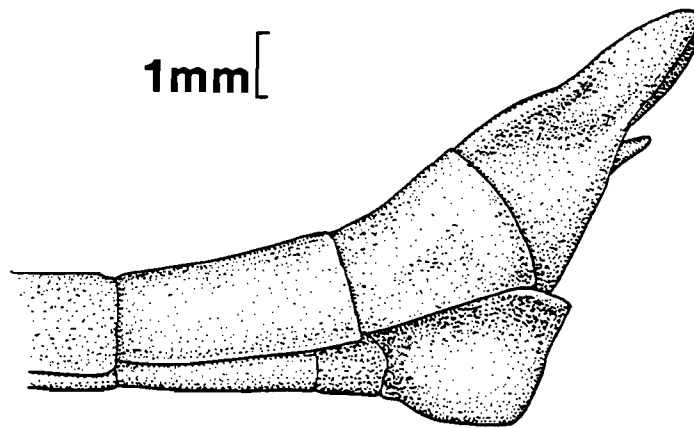

Figure 23 *L. modestus* male: apex of abdomen.

Antennae longer than the fore legs, basal segment flattened. Head longer than wide, with two small tubercles on a slight transverse ridge between the eyes; eyes brown or yellow-orange.

Pronotum slightly longer than wide. Middle of mesonotum 1.6mm wide. Metanotum arched, almost three times longer than median segment. Abdominal segments 2-7 of similar size, 8th half as long, 9th slightly shorter than 8th, 10th split and laterally compressed to form two triangular lobes (Figure 23) with small spines on the inside. Poculum short, deep, rounded, setose. Cerci short and conical.

Fore femur with base strongly compressed and incurving, apex of ventro-posterior carina with 1-2 minute spines. Dorsal surface of mid femur smooth, very rarely with an almost imperceptible swelling. Ventro-posterior carina of mid femur with one medium and two minute spines at the apex; ventro-anterior carina with one small and two minute spines at the apex. Hind femora strongly laterally compressed, ventral carinae each with two minute spines at the apex. Base of mid tibia with a very small triangular lobe on the ventral surface.

Egg (Figures 24-30)

Capsule as high as long, narrower than high; shape complex (Figure 25), indented at polar end, narrow at opercular end, with six more or less triangular depressions on each lateral surface; surface finely punctate; opercular end with a small collar. Capsule mid to dark brown, usually with a small white spot in each depression (Figure 30), micropylar plate and collar pale cream, capitulum cream. Micropylar plate almost an equilateral triangle with rounded corners, apex towards operculum, micropylar cup close to polar end of plate. Operculum flat, a narrow oval tending towards a rhombus, with a central capitulum which is very easily detached. Typical measurements: length 3.9-4.2mm, height 3.9-4.0mm, width 2.4-2.5mm, capitulum length (fresh) 0.5mm.

Eggs produced by my only specimen from Sepilok (PEB-1841) were uniformly pale yellow and did

not hatch, otherwise they were indistinguishable from the typical eggs.

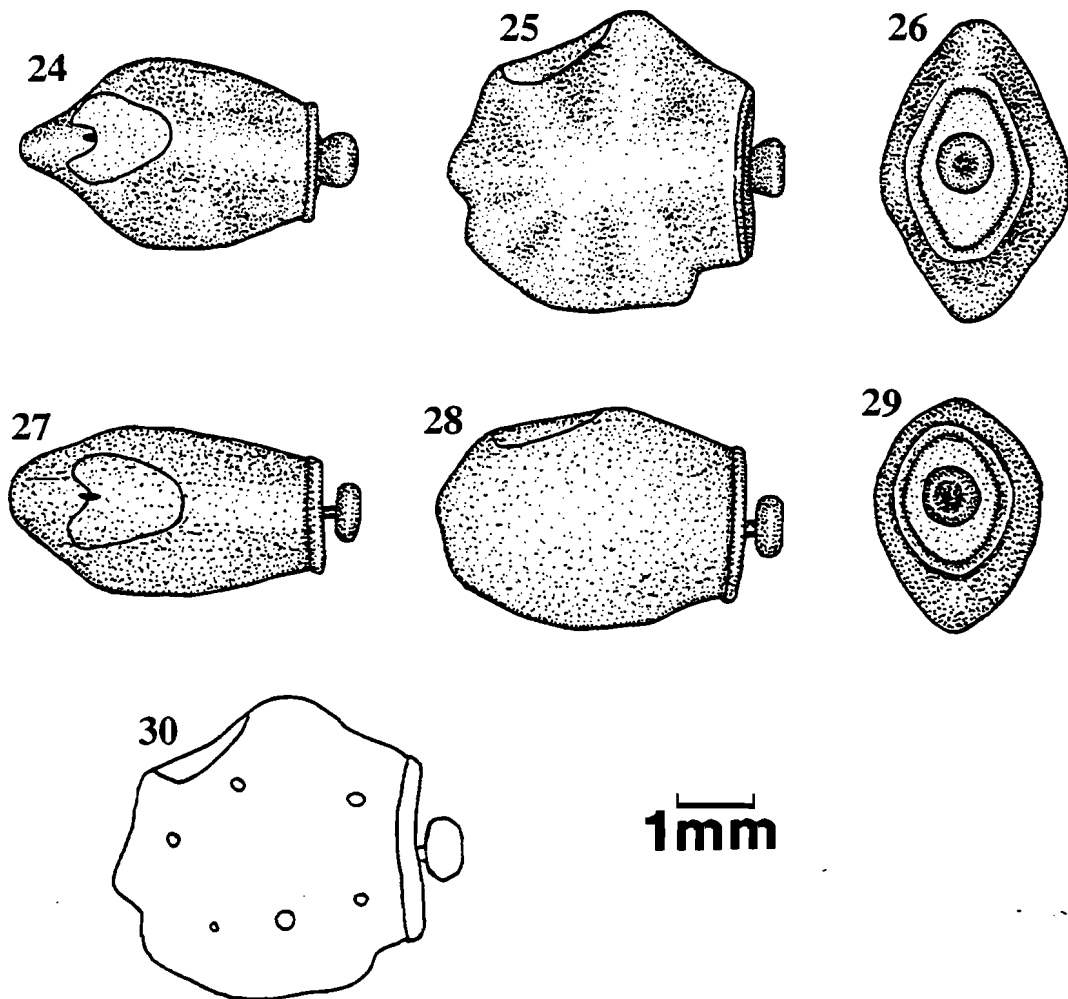

Figures 24-26 & 30 Normal eggs of *L. modestus*.

Figures 27-29 Abnormal eggs of *L. modestus*.

Abnormal eggs (Figures 27-29) were consistently produced by one captive reared female from stock reared from material collected at Palangkaraya and Ratu Miri. Capsule longer than high, higher than wide; shape tending towards cylindrical, with only a few slight depressions on the lateral surfaces; surface finely punctate, with distinct collar (larger than in a normal egg). Capsule dark grey, lacking distinct white spots although a few pale spots may be visible under magnification; capitulum yellow-orange. Micropylar plate grey, otherwise as in normal eggs. Operculum similar to a normal egg, but wider (Figure 29). Typical measurements: length 4.1-4.3mm, height 2.8-2.9mm, width 2.0-2.1mm, capitulum (fresh) 0.5mm.

These abnormal eggs are very similar to Hausleithner's illustration (1989, fig 3g) of an egg removed from the body of a type specimen, this suggests that this individual is producing the eggs in an incompletely developed form. It remains to be seen if they will hatch.

Eggs are laid at a rate of about 3 per week and take about six months to hatch.

Variation

This species shows variation in coloration, size, shape of lobes on the middle femur and on the middle tibia, and in the shape and coloration of the egg. The variation in the shape of the eggs is probably not normal. Variation in the size of adults appears to be dependant on the geographical origin, specimens from Kelambenkari and the unknown Kalimantan locality are considerably smaller than my other specimens.

Rearing

I have reared these in my standard cages, with nymphs reared at high humidity in enclosed cages, the adults are currently being successfully maintained in a drier and better ventilated cage. This species is quite easy to rear although males and some of the females only survived 1-2 months, other females survived more than seven months as adults. It is possible that the early deaths were due to insufficient ventilation as they were in a fully enclosed cage at the time.

Lonchodes modestus feeds on bramble, eucalyptus, hawthorn, oak, pyracantha, raspberry, and rose; I have not tried any other plants.

Lonchodes strumosus (Brunner, 1907)

Prisomera strumosum Brunner, 1907: 287.

Lonchodes strumosus (Brunner); Günther, 1932c: 379, pl. 9.2, 12.11, 13.7.

The male and egg have not been described previously, and the female has only been described from a nymph. Both the original description and Günther's illustrations are based on the same single female nymph.

Origin of the culture

In August 1990 I collected a female from 210m on Mt Serapi in Sarawak. This arrived safely in the U.K. and went on to lay over 100 eggs and started the culture PSG 127. In August 1991 Ian Abercrombie found an adult female at 670m on Mt Serapi; this supplemented the culture by laying a few eggs before it died.

Distribution

This species seems to be relatively rare. On my various trips to Borneo only six specimens have been found although I have spent many nights collecting on Mt Serapi. I have found one adult male and two nymphs on Mt Santubong, and two females (including Ian's) and one male on Mt Serapi. The Sarawak Museum has three male specimens: one from "Matang Road" collected in 1911, and two from Kuching

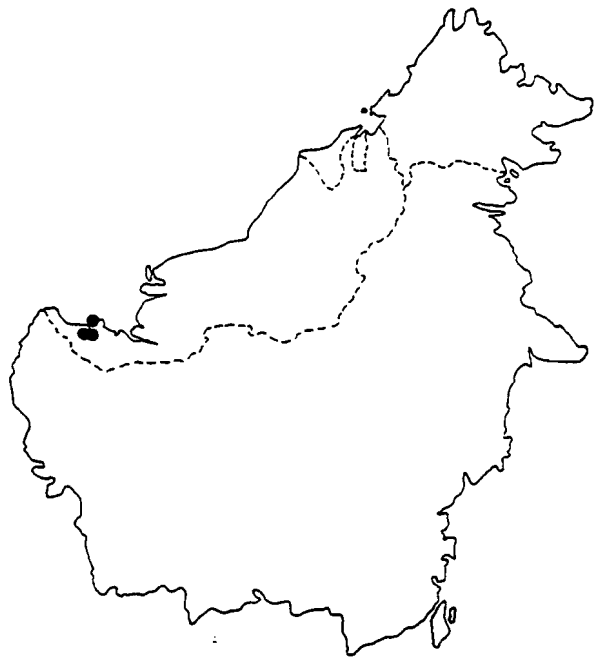

Figure 31 Distribution of *L. strumosus*.

collected in 1900. Kuching is now quite a modern city and so much larger than in 1900 that it is extremely unlikely that this species still occurs in Kuching. Matang road runs from Kuching to the base of Mt Serapi, there is no way of knowing from which part of the road it came. There are no published records of this species except the vague "North Borneo" of Brunner's original specimen. Although "North Borneo" probably refers to what is now Sabah (previously British North Borneo), this may not be the case, so I have omitted this from the distribution map (Figure 31).

Female (Figures 34-38 & 41)

Body and legs mid-brown, or dark brown, or silver-grey, mottled with dark grey or dark brown. Fore legs often with yellowish-brown markings; posterior surface of hind femur bright red. Body granulose, tuberculate, scabrous and usually verrucose; of uniform width except where large verrucose swellings protrude.

Antennae as long as the fore legs, basal segment wide and flattened. Head flat, longer than wide. Pronotum one-and-a-half times longer than wide. Mesonotum usually with a verrucose swelling near the anterior; this is highly variable, at the extremes it may be absent (PEB-694, figure 36) or it may double both the width and height of the mesonotum (PEB-693, figures 34-35). Occasionally there are swellings on the anterior of the metanotum and on the median segment; there may be transverse crests on the posteriors of the mesonotum and the median segment (none of my specimens have a crest on the metanotum). Metanotum one-and-a-half times longer than median segment.

Abdominal segments 2-7 twice as long as wide, often with verrucose swellings on the anterior margin, posterior margin, and lateral surfaces. Although very variable, verrucose swellings are most common on anterior of 3rd segment and on the lateral margins of the 5th; the 2nd often has a transverse crest on the posterior margin. Segment 8 as long as wide, 9-10 short. Lamina supraanalis varies from short, rounded and carinate (Figure 37), to a long flattened lobe (Figure 38). The praeopercular organ is a roughly diamond-shaped ridge, with two small lobes at the posterior. Operculum flat, with a short apical keel, and two lateral carinae; the apex is verrucose.

Fore femur and fore tibia have a large curved lamella on the dorsal surface and smaller lamellae on the ventral carinae; there is little variation in the shape of the lamellae. When the legs are together the lamellae form a hollow tube which is the same diameter as the body. Middle femur with a series of lobes on the dorsal surface (Figure 41), composed of 4-5 small lobes basally, a large lobe which is curved on the basal side and serrated on the apical side, and 2-3 small lobes apically; there is little variation between specimens. Ventral carinae of middle femur each with three small triangular spines and two minute spines near the apex. Middle tibia with a slight lamella on the dorsal surface. Hind femur laterally compressed, with a small triangular lobe on the ventral surface near the base; with two small triangular spines near the apex of the ventro-posterior and ventro-anterior carinae. Tarsi all short with tarsomeres 1-4 decreasing in size evenly.

Male (Figures 32-33 & 39-40)

Long slender body, legs unarmed except for spines on the apices of the ventral carinae of the femora. Distinguished from other *Lonchodes* species which are in culture by the strongly arched metanotum and the swollen posterior margins of the abdominal segments. Head, body and legs dark brown and granulose both ventrally and dorsally; posterior surface of hind femora red or reddish-brown.

Figure 32-33 *L. strumosus*, dorsal and lateral views of two different males.
Figures 34-35 *L. strumosus*, dorsal and lateral views of female (PEB-693).
Figure 36 *L. strumosus*, lateral view of female (PEB-694).

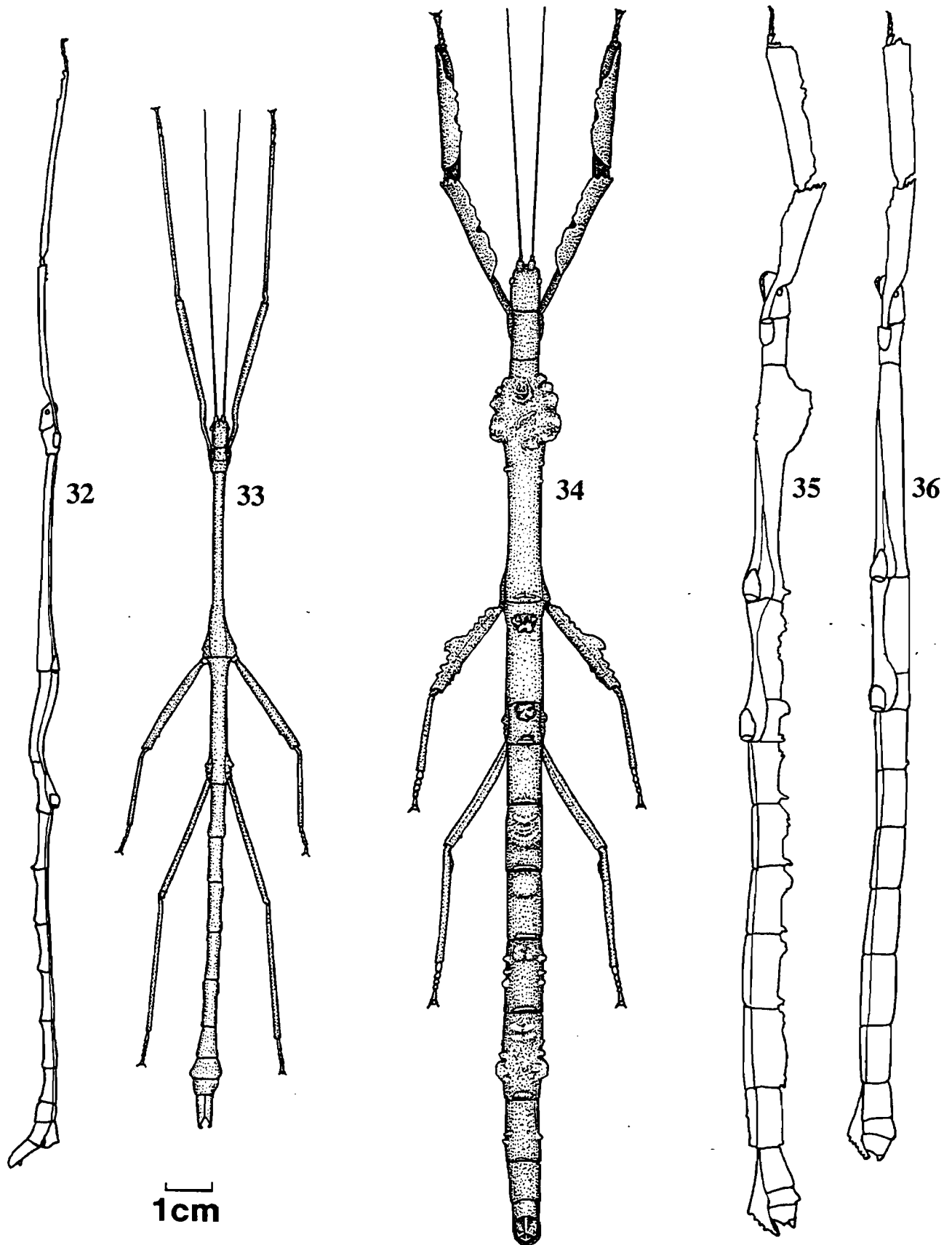

Figures 37-38 *L. strumosus*, apex of female abdomens.

Figures 39-40 *L. strumosus*, apex of male abdomen.

Figure 41 *Lonchodes strumosus*, middle femur of female.

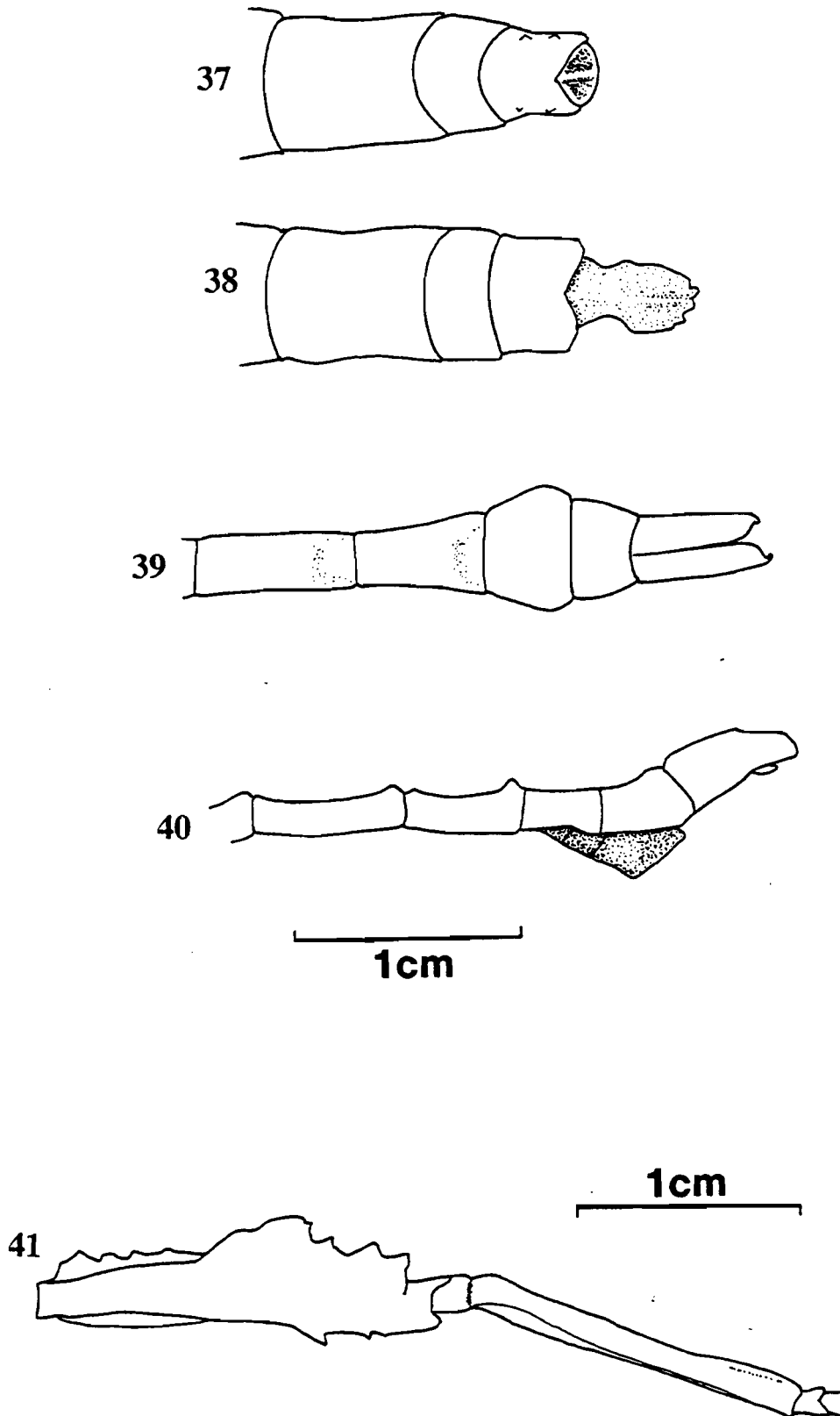

Antennae longer than the fore legs, basal segment flattened. Head about twice as long as wide, with two small tubercles on a slight swelling between the eyes. Pronotum slightly longer than wide. Middle of mesonotum 2.0mm wide. Metanotum strongly arched (Figure 32), about four times longer than median segment but frequently indistinguishable from the median segment. Abdominal segments 2-6 of similar size, 7th shorter and widening, 8th short widening then narrowing (segment is hexagonal), 9th short and narrowing, 10th split and to form two rectangular lobes (Figures 39-40) with small spines on the ventral surface of the apex. Posterior of segments 2-7 with a raised swelling, anterior of third segment with a pair of small tubercles. Poculum short, deep, angular, posterior with a small longitudinal carina; apex truncated. Cerci dorso-ventrally flattened, short, with rounded apices.

Fore femur with base strongly compressed and incurving, apex of ventro-posterior carina with two small triangular spines. Dorsal surface of mid femur with a slight angular swelling, occasionally smooth. Ventro-posterior carina of mid femur with two medium, and two minute spines at the apex; ventro-anterior carina with two minute spines at the apex. Hind femora strongly laterally compressed, ventro-anterior carina with two small spines at the apex, ventro-posterior carina with two minute spines at the apex. Dorsal surface of anterior tibia with a narrow lamella which widens at the apex.

Variation

For some time after collecting the first female from Mt Serapi I considered this to be an undescribed species as there are few described species of *Lonchodes* of this size and it was clearly not one of those. After rearing more females I realised that it is variable and that the species had been described from a penultimate instar female nymph with a smaller mesonotal swelling. The femoral lobes of the females seem to be quite consistent but the form of the body varies greatly, ranging from the almost completely smooth specimen collected by Ian Abercrombie (Figure 36), to the extremely verrucose specimen which I originally collected (Figures 34-35). Although the females of this species are very variable; as usual in *Lonchodes*, the males show no significant variation.

Egg (Figures 42-45)

Capsule a laterally compressed sphere; smooth, without any surface ornamentation. Uniformly mid brown, with micropylar plate almost imperceptibly lighter. Micropylar plate a broad band running from the polar end almost to the operculum, widening slightly at the polar end, apices of the band rounded; micropylar plate is not raised above the capsule. Micropylar cup indistinct. Operculum oval, flat, with a central capitulum on a narrow stalk. Typically: length 4.3mm, height 3.9mm, width 3.2mm, capitulum length (dehydrated) 0.3mm.

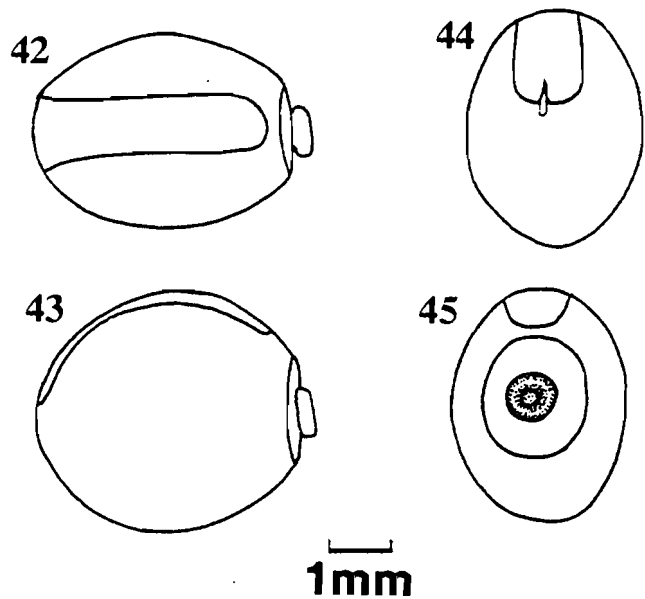

Figures 42-45 Egg of *L. strumosus*: dorsal, lateral, polar, and opercular views.

Rearing

In captivity this species seems to need good ventilation to do well. Most of my first generation died, either as young nymphs or almost immediately after becoming adult; this was probably due to insufficient ventilation because Ian Abercrombie had much better results in well ventilated cages. The egg laying rate is about 1.6 per day. Unfortunately I have mislaid some of my records for this species so I do not know the exact number of eggs laid by the original specimen although I think it was about 180, neither do I know the hatch rate although it was at least 30% because I have over 65 preserved specimens from the first generation. The original specimen was caught on 13th August 1990 and the first egg hatched on 22nd February 1991, i.e. 6 months incubation at room temperature.

The females of *L. strumosus* are excellent stick mimics. When disturbed, and when at rest during daylight, the fore legs are brought together and held straight in line with the body, the middle legs are folded and held against the body, and the hind legs are held straight alongside the body. The fore legs enclose the antennae and match the diameter of the body so well that the head and legs are indistinguishable from the body. The females will remain motionless in this position for some considerable time. If the legs are carefully forced open the insect will shed the leg and still remain motionless. Particularly in the first three instars, this species often hangs from the foodplant by its back feet only; occasionally they hang by just the front feet.

Lengths (mm)	<i>C. cristatus</i>		<i>L. modestus</i>		<i>L. strumosus</i>	
	♀	♂	♀	♂	♀	♂
Total	98-126	75-89	110-159	88-118	143-165	111-131
Antennae	> 32-41	41-51	58-86	66-95	38-46	58->59
Head	4.5-5.0	3.5	5.5-7.5	4.0-4.5	6.5-7.5	4.5-5.0
Pronotum	5.0	3.0	5.0-7.5	3.0-4.5	8.0-8.5	4.0
Mesonotum	26.5-32.5	20.5-24.5	25.0-36.5	21.5-29.5	33.0-41.0	29.5-36.5
Metanotum	11.0-16.5	10.0-13.0	12.0-20.0	11.5-17.0	16.5-17.5	16.0-18.5
Median segment	4.5-6.0	4.0-4.5	5.0-7.5	4.0-5.0	7.0-7.5	4.0-5.5
Fore femur	19.0-22.5	20.0-21.0	27.5-39.5	28.0-38.0	22.0-25.0	23.5-28.0
Fore tibia	17.0-20.0	19.5-22.0	23.5-41.5	30.0-40.0	20.5-24.0	28.0-32.0
Fore tarsus	5.5-6.0	5.0-6.0	6.0-11.0	8.0-10.0	6.5-7.0	5.5
Mid femur	15.0-18.0	14.0-15.5	19.5-26.5	20.0-24.0	16.0-19.0	16.5-19.0
Mid tibia	13.0-15.5	12.0-14.0	19.5-24.0	20.0-23.0	14.0-15.5	14.0-15.0
Mid tarsus	5.0	4.0-4.5	7.0-9.0	6.0-7.5	6.5-7.0	5.0
Hind femur	17.0-20.5	15.5-18.0	24.5-34.0	24.0-32.0	18.5-22.5	19.5-23.0
Hind tibia	18.0-21.0	17.5-21.5	26.5-37.0	29.0-37.0	18.5-22.0	21.0-25.0
Hind tarsus	5.5-6.0	4.0-5.0	7.0-9.0	7.5-8.0	7.5-8.0	6.0

Table 1 Measurements of the longest and shortest specimens of each species.

References

- Bragg, P.E.** (1987) Cage construction. *Phasmid Study Group Newsletter*, **32**: 8-9.
- Bragg, P.E.** (1989) A cage constructed for stick insects. *Bulletin of the Amateur Entomologists' Society*, **48**(365): 160-161.
- Brunner von Wattenwyl, C.** (1907) *Die Insektenfamilie der Phasmiden*. Vol. 2. Leipzig.
- Giglio-Tos, E.** (1910) Fasmidi esotici del Museo zoologico di Torino e del Museo civico di Storia naturale di Genova. *Bollettino dei Musei di Zoologia ed Anatomia comparata della R. Università di Torino*, **25**(625): 1-56.
- Günther, K.** (1932) Phasmoiden des Kina Balu auf Borneo, aus dem Hamberger Zool. Museum. *Wiener Entomologische Zeitung.*, **49**(4): 313-320.
- Günther, K.** (1943) Die Phasmoiden (Orthoptera) der "Borneo-expedition Dr. Nieuwenhuis" aus dem Stromgebiet des oberen Mahakam. *Eos Madrid*, **19**: 149-172.
- Hausleithner, B.** (1989) Die Eier einiger Lonchodes-Arten (Phasmida). *Entomologische Zeitschrift*, **99**(8): 102-112.
- Hausleithner, B.** (1990) Die Eier einiger *Carausius*-Arten und einige Bemerkungen zu diesem Genus (Phasmatodea). *Entomologische Zeitschrift*, **100**(21): 393-400.
- Hausleithner, B.** (1991) Eine Phasmidenausbeute aus dem Gebiet des Mount Kinabalu, Borneo (Phasmatodea). *Nachrichten des Entomologischen Vereins Apollo, Frankfurt*, N.F. **11**(4): 217-236.